





Hand tools

TRIAC S	10
TRIAC PID	10
TRIAC BT	14
HOT JET S	18
GHIBLI	20
SONORA S1	21
ELECTRON	22
FORTE S3	24
HOTWIND S	25
LABOR S	26
WELDING PEN R / WELDING PEN S	27
DIODE PID/ DIODE S	28
MINOR	29
ROBUST	30
General Accessories	31
General Accessories / Welding rods	33





Hand tool

TRIAC PID

Closed loop control of temperature and monitoring of functions thanks to micro processor. The popular hand tool for top quality results.

- Reproducible results thanks to digital display of set and actual values of temperature.
- Constant temperature independent of voltage fluctuations and environmental conditions.
- Adaptor tube with heat protection
- Electronic protection of heating element
- Motor shut-off at minimal carbon level

Technical Data

Voltage	V~	230 / 120
Power	W	1600
Frequency	Hz	50 / 60
Temperature	°C	50 – 600
Size (L x Ø)	mm	340 x 90, handle Ø 56
Weight	kg	1.1 (without 3 m cord)
Marking of conformity	CE	
Approval Mark	S	
Certification Scheme	CCA	
Protection Class II	□	

Artikel-Nr.

- 100.741 TRIAC PID 230V / 1600W for snap-fit nozzles with Euro plug
 100.742 TRIAC PID 230V / 1600W for screw-on nozzles with Euro plug
 111.165 TRIAC PID 120V / 1600W for snap-fit nozzles with UK plug

Hand tool

TRIAC S

The reliable, cost-effective and proven hand tool with stepless adjustment of temperature range.

- Adaptor tube with heat protection
- Electronic protection of heating element
- Motor shut-off at minimal carbon level
- Multiple replacement of carbon brushes possible
- Suitable for continuous operation

Technical Data

Voltage	V~	230
Power	W	1600
Frequency	Hz	50 / 60
Temperature	°C	20 – 700
Size (L x Ø)	mm	340 x 90, handle Ø 56
Weight	kg	1.1 (without 3 m cord)
Marking of conformity	CE	
Approval Mark	S	
Certification Scheme	CCA	
Protection Class II	□	

Artikel-Nr.

- 100.705 TRIAC S 230V / 1600W for snap-fit nozzles with Euro plug
 100.706 TRIAC S 230V / 1600W for screw-on nozzles with Euro plug
 100.709 TRIAC S 230V / 1600W for snap-fit nozzles with Australian plug
 112.230 TRIAC S 230V / 1600W for snap-fit nozzles with UK plug black
 109.987 TRIAC S 120V / 1600W for snap-fit nozzles with UK plug yellow



Working with the reliable TRIAC, the specialist produces perfect welding results.











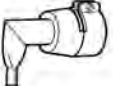

Welding of the connectors with TRIAC PID and push-fit wide slot nozzle.



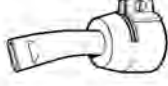

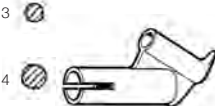
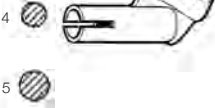
The handy transport box provides ample room for the required equipment.





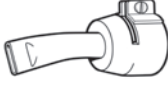

Accessories TRIAC PID / TRIAC S

Roofing







107.124		Angled nozzle 20 mm, 90°, push-fit
107.125		Angled nozzle 20 mm, 60°, push-fit
107.132 107.130 107.133 128.535		Wide slot nozzle, push-fit, 40 mm 40 mm, 60° bent 40 mm, perforated 30 mm, 45° bent
107.129		Wide slot nozzle 60 mm for bitumen, push-fit
107.131		Wide slot nozzle 80 mm, push-fit
107.123		Wide slot nozzle 20 mm, push-fit
100.303 105.578		Tubular nozzle \varnothing 5 mm, push-fit Version extra strong
106.989		Speed weld nozzle 3 mm, push-fit on tubular nozzle \varnothing 5 mm
106.990		Speed weld nozzle 4 mm, push-fit on tubular nozzle \varnothing 5 mm
106.991		Speed weld nozzle 5 mm, push-fit on tubular nozzle \varnothing 5 mm
100.296		Heating element, 230 V, 1550 W, for TRIAC PID
100.689		Heating element, 230 V, 1550 W, for TRIAC S

Billboards / Tarpaulins

107.123		Wide slot nozzle 20 mm, angled, push-fit
105.487		Wide slot nozzle 20 mm, bent and angled, push-fit

107.132 107.130 107.133 128.535		Wide slot nozzle, push-fit 40 mm 40 mm, 60° bent 40 mm, perforated 30 mm, 45° bent
107.124		Angled nozzle 20 mm, 90°, push-fit
107.125		Angled nozzle 20 mm, 60°, push-fit
105.492		Wide slot nozzle 20 mm, straight jaw, 120° bent at right angle
100.296		Heating element, 230 V, 1550 W, for TRIAC PID
100.689		Heating element, 230 V, 1550 W, for TRIAC S





Civil Engineering / Tunnel / Landfill sites

107.123		Wide slot nozzle 20 mm, push-fit
107.132		Wide slot nozzle 40 mm, push-fit
107.135		Wide slot nozzle 40 mm, PTFE-coated, push-fit
100.296		Heating element, 230 V / 1550 W, for TRIAC PID
100.650		Heating element, 120 V / 1600 W, for TRIAC PID
100.689		Heating element, 230 V / 1550 W, for TRIAC S
100.702		Heating element, 120 V / 1550 W, for TRIAC S



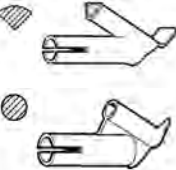

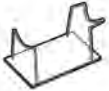
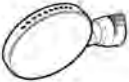

The professional Handtool for work on the roof.

Apparatus and container construction (with push-fit nozzle)

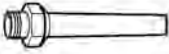

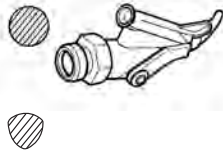

100.303 105.578		Tubular nozzle \varnothing 5 mm, for versions with nozzles, push-fit Version extra-strong
106.992 106.993 106.989 106.990 106.991		Speed weld nozzle, push-fit on tubular nozzle \varnothing 5 mm 5.7 mm, profile A 7 mm, profile B 3 mm 4 mm 5 mm
106.996		Tacking nozzle, push-fit on tubular nozzle \varnothing 5 mm
107.348		Device rest
107.344		Welding mirror 135 mm, push-fit
100.296 100.689		Heating element, 230 V, 1550 W, for TRIAC PID Heating element, 230 V, 1550 W, for TRIAC S

Apparatus and container construction (with screw-on nozzle)

105.622		Tubular nozzle, \varnothing 5 mm, screw-on
106.988		Tacking nozzle, screw-on
113.666 113.399 113.876 113.874		drawing nozzle, \varnothing 3 mm drawing nozzle, \varnothing 4 mm, with tacking tip, screw-on drawing nozzle, \varnothing 3 mm drawing nozzle, \varnothing 4 mm, without tacking tip, screw-on

113.670 113.877 106.986 106.987		drawing nozzle triangular shaped, with tacking tip, screw-on, 90 – 5.7 mm drawing nozzle triangular shaped, without tacking tip, screw-on 5.7 mm, profile A 7 mm, profile B 7 x 5.5 mm
126.552		drawing nozzle \varnothing 4 mm, screw-on for fluor plastics

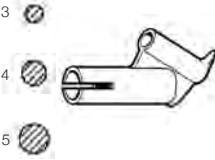
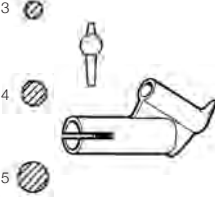
Floors / Interior Design

100.303 105.578		Tubular nozzle \varnothing 5 mm, for versions with nozzles, push-fit Version extra-strong
106.982		Extension nozzle \varnothing 5 mm, 150 mm
106.989 106.990 106.991		Speed weld nozzle 3 mm, push-fit on Tubular nozzle \varnothing 5 mm Speed weld nozzle 4 mm, push-fit on Tubular nozzle \varnothing 5 mm Speed weld nozzle 5 mm, push-fit on Tubular nozzle \varnothing 5 mm
105.431 105.432 105.433		Speed weld nozzle 3 mm, with small air-slide, push-fit on Tubular nozzle \varnothing 5 mm Speed weld nozzle 4 mm, with small air-slide, push-fit on Tubular nozzle \varnothing 5 mm Speed weld nozzle 5 mm, with small air-slide, push-fit on Tubular nozzle \varnothing 5 mm
107.139		Speed weld nozzle 4.5 x 12 mm for fillet weld, push-fit on Tubular nozzle \varnothing 5 mm





The TRIAC S hand welding tool, used for welding linoleum, equipped with a speed weld nozzle.



TRIAC PID: monitoring of welding temperature for top quality.





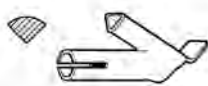

Welding a patch with the TRIAC PID on a building site.

107.137		Speed weld nozzle for tape welding 8 mm, push-fit on Tubular nozzle Ø 5 mm
100.296		Heating element, 230 V, 1550 W, for TRIAC PID
100.689		Heating element, 230 V, 1550 W, for TRIAC S

106.997		Rotary burr Ø 6 mm (for drilling machine)
106.992		Speed weld nozzle 5.7 mm, push-fit on tubular nozzle Ø 5 mm

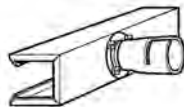
Shrinking and vehicle repairs

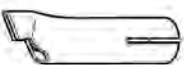
107.324		sieve reflector 12 × 10 mm, push-fit on Tubular nozzle Ø 5 mm
107.337		sieve reflector 50 × 35 mm, push-fit
107.338		sieve reflector 35 × 20 mm, push-fit
107.326		Shell reflector 25 × 150 mm, push-fit
107.307		Spoon reflector 27 × 35 mm, push-fit
107.339		Soldering reflector 17 × 34 mm, push-fit
106.996		Tacking nozzle, push-fit on tubular nozzle Ø 5 mm

Other versions on request.
Technical data are subject to change without prior notice.



Well balanced design for precise welding.

Hand tool

TRIAC BT

The TRIAC BT fulfills all of the functionality and design requirements necessary for successful plastic welding. Weighing just one kilogram, it is the lightest in its class and is made from high-quality material. Every TRIAC BT kit undergoes stringent quality checks before leaving the factory in Switzerland. The sturdy tool box includes everything an expert technician requires.

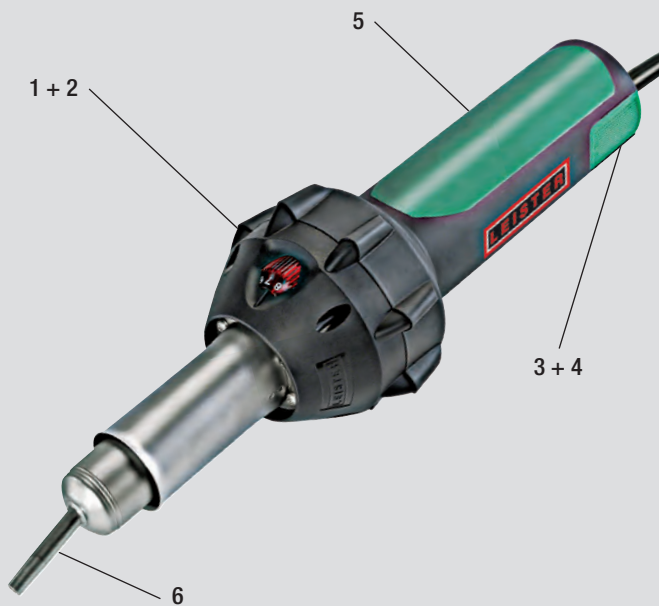

1		Temperature setting: Convenient and reliable temperature adjustment
2		Accidental start-up protection: The temperature adjustment becomes lit-up if the power to the tool is interrupted
3		Filter: The fine mesh air filter prevents dirt from clogging the air inlet of the tool
4		Filter cleaning: The air filters on both sides can be easily removed and cleaned
5		Tool handle: Ergonomically designed handle with soft grip covering for a secure hold
6		Nozzle: Extra strong integral 5 mm universal nozzle
7		Spare heating element: Protected, packed in a box and within easy reach
8		Tool box: Enough space for all the accessories the professional needs



Contained in delivery



Intuitive design and easy handling for precision welding.



Perfect for detailed work.

Hand tool

TRIAC BT tarpaulin welding-set

The TRIAC BT tarpaulin welding-set is the perfect set for the ambitious tarpaulin specialist.

- Light and easy to handle
- Ergonomic handle for welding without strain
- Electronically protected heating element
- Integral precision nozzle
- Built in start-up protection in case of power interruption

Accessories TRIAC BT

140.160		Pressure roller 40 mm with ball bearings, (Silicone)
140.161		Pressure roller 28 mm with ball bearings, (Silicone)
136.916		Heating element, 230 V / 1550 W
116.586		Tool box, for TRIAC BT, TRIAC PID, TRIAC S, ELECTRON
137.855		Leister-Cutter with 4 spare blades

Technical Data

Voltage	V~	230
Power	W	1600
Temperature	°C	20 – 700
Size (L x Ø)	mm	370 x 90, handle Ø 56
Weight	kg	1.0 (without 2 m cord)
Marking of conformity	CE	
Approval Mark	Ⓢ	
Certification Scheme	CCA, CB	
Protection Class II	□	

Article No.

- 136.937 TRIAC BT 230V / 1600W tarpaulin kit 20mm with Euro-plug
 136.938 TRIAC BT 230V / 1600W tarpaulin kit 40mm with Euro-plug

Within scope of supply: Transport box, spare heating element, pressure roller 40 mm



Contained in delivery

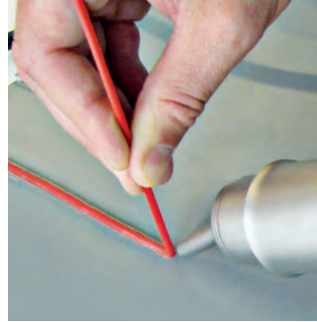

Perfect for hot gas extrusion welding of containers and apparatuses

Hand tool

TRIAC BT plastic welding kit

Das TRIAC BT Plastic welding kit is the perfect kit for the ambitious container and apparatus engineers.

- Light and easy to handle
- Ergonomic handle for welding without strain
- Electronically protected heating element
- Integral universal nozzle
- Built in start-up protection in case of power interruption

Technical Data







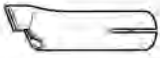

Voltage	V~	230
Power	W	1600
Temperature	°C	20 – 700
Size (L × Ø)	mm	370 × 90, handle Ø 56
Weight	kg	1.0 (without 2 m cord)
Marking of conformity		CE
Approval Mark		Ⓢ
Certification Scheme		CCA, CB
Protection Class II		□

Article No.

136.939 TRIAC BT 230V / 1600W plastic welding kit with Euro-plug

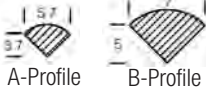
Included in delivery: TRIAC BT, tool box, spare heating element, tacking nozzle and speed welding nozzle 5.7 mm (profile A)

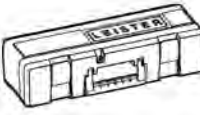
Accessories TRIAC BT

106.996		Tacking nozzle, push fit
106.989	3 	Speed weld nozzle, push-fit (3 mm)
106.990	4 	Speed weld nozzle, push-fit (4 mm)
106.991	5 	Speed weld nozzle, push-fit (5 mm)
106.992		Speed weld nozzle, push-fit (5.7 mm, A)
106.993		Speed weld nozzle, push-fit (7 mm, B)
136.916		Heating element, 230 V / 1550 W
116.586		Tool box, for TRIAC BT, TRIAC PID, TRIAC S, ELECTRON
137.855		Leister-Cutter with 4 spare blades



Contained in delivery



Well balanced design for precise welding of floor coverings.

Hand tool

TRIAC BT floor welding kit

The TRIAC BT floor welding kit is the ideal kit for the ambitious flooring technician.

- Light and easy to handle
- Ergonomic handle for welding without strain
- Electronically protected heating element
- Integral universal nozzle
- Built in start-up protection in case of power interruption

Technical Data

Voltage	V~	230
Power	W	1600
Temperature	°C	20 – 700
Size (L x Ø)	mm	370 x 90, handle Ø 56
Weight	kg	1.0 (without 2 m cord)
Marking of conformity	CE	
Approval Mark	S	
Certification Scheme	CCA, CB	
Protection Class II	□	

Article No.

136.936 TRIAC BT 230V / 1600W floor welding kit with Euro-plug

Included in delivery: TRIAC BT, transport box, spare heating element, Speed weld nozzle 5 mm and speed weld nozzle with small air-slide

Accessories TRIAC BT

107.139		Speed weld nozzle, push-fit (4.5 x 12 mm)
106.989	3	Speed weld nozzle, push-fit (3 mm)
106.990	4	Speed weld nozzle, push-fit (4 mm)
106.991	5	Speed weld nozzle, push-fit (5 mm)
105.431	3	Speed weld nozzle, with small air-slide, push-fit (3 mm)
105.432	4	Speed weld nozzle, with small air-slide, push-fit (4 mm)
105.433	5	Speed weld nozzle, with small air-slide, push-fit (5 mm)
136.916		Heating element, 230 V / 1550 W
116.586		Tool box, for TRIAC BT, TRIAC PID, TRIAC S, ELECTRON
137.855		Leister-Cutter with 4 spare blades



Hand tool

HOT JET S

As the most compact hand tool from Leister, the HOT JET S' low weight of 600 g, incl. cord and slim handle, ensures fatigue-free welding and high power.

- The smallest Leister hand tool
- Electronic steplessly controlled temperature
- Electronic steplessly controlled air flow
- Low noise
- Integrated flexible tool stand

Technical Data

Voltage	V~	230
Power	W	460
Frequency	Hz	50 / 60
Temperature	°C	20 – 600
Pressure static	Pa	max. 1600 (16 mbar)
Size (L x Ø)	mm	235 x 70, handle Ø 40
Weight	kg	0.4 (without 3 m cord)
Marking of conformity	CE	
Approval Mark	Ⓢ	
Certification Scheme	CCA	
Protection Class II	□	

Artikel-Nr.

- 100.648 HOT JET S 230V / 460W with Euro plug
- 112.229 HOT JET S 230V / 460W with UK plug black
- 100.854 HOT JET S 230V / 460W with AUS plug
- 100.861 HOT JET S 120V / 460W with USA plug

Accessories HOT JET S

107.141		Wide slot nozzle 15 mm, push-fit
107.142		Wide slot nozzle 20 mm, push-fit
107.144		Tubular nozzle Ø 5 mm, push-fit
105.567		Extension nozzle Ø 5 x 150 mm, straight
105.556		Angled nozzle 20 mm, 90° angled, push-fit
106.996		Tacking nozzle, push-fit on Tubular nozzle Ø 5 mm
106.989		Speed weld nozzle 3 mm, push-fit on Tubular nozzle Ø 5 mm
106.990		Speed weld nozzle 4 mm, push-fit on Tubular nozzle Ø 5 mm
106.991		Speed weld nozzle 5 mm, push-fit on Tubular nozzle Ø 5 mm
106.992		Speed weld nozzle, push-fit (5.7 mm, A)
106.993		Speed weld nozzle, push-fit (7 mm, B)
105.431		Speed weld nozzle 3 mm, with small air-slide, push-fit on Tubular nozzle Ø 5 mm
105.432		Speed weld nozzle 4 mm, with small air-slide, push-fit on Tubular nozzle Ø 5 mm
105.433		Speed weld nozzle 5 mm, with small air-slide, push-fit on Tubular nozzle Ø 5 mm









Fitting a solder shrink connection with HOT JET S and a push-fit sieve reflector.



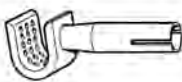
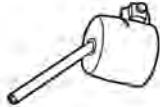

The HOT JET S is especially suited to carry out work in areas which are difficult to access.



The small and light HOT JET S is especially suited to carry out work where space is tight.

107.137		Speed weld nozzle for tape welding 8 mm, push-fit on Tubular nozzle Ø 5 mm
107.139		Speed weld nozzle 4.5 x 12 mm for fillet weld, push-fit on Tubular nozzle Ø 5 mm
107.324		Sieve reflector 12 x 10 mm, push-fit on Tubular nozzle Ø 5 mm
107.146		Soldering nozzle Ø 2 mm
107.151		Soldering nozzle Ø 4 mm
107.148		Soldering nozzle Ø 3 x 1.5 mm, oval
107.310		Sieve reflector 35 x 20 mm, push-fit
107.311		Sieve reflector 50 x 35 mm, push-fit
107.312		Spoon reflector 25 x 30 mm, push-fit

107.305		Ironing nozzle 15 x 25 mm
100.818		Heating element, 230 V / 435 W



Simple heating up fibre optic loose tube cables for further processing.



Welding pipes

Hand tool

GIBLI

Derived from a hot desert wind – GIBLI certainly lives up to its name! Thanks to two-step airflow switching and steplessly adjustable temperature, it can be used for the most diverse applications.

- Universal tool for welding and shrinking
- Welding results independent of voltage fluctuations and ambient temperature
- Two-step selectable air flow
- Extensive range of accessories

Technical Data

Voltage	V~	230
Power	W	2000
Frequency	Hz	50 / 60
Temperature	°C	20 – 600
Pressure static	Pa	Stufe 2: 1500 (15 mbar) Stufe 3: 2100 (21 mbar)
Size (L × B × H)	mm	195 × 85 × 160, handle Ø 57
Weight	kg	0.9 (without 3 m cord)
Marking of conformity		CE
Approval Mark		Ⓢ
Certification Scheme		CCA
Protection Class II		□

Article No.

101.881 GIBLI 230V / 2000W with Euro plug
101.887 GIBLI 120V / 1500W with USA plug

More versions on request

Accessories GIBLI

106.998		Wide slot nozzle 20 mm, push-fit
106.999		Wide slot nozzle 40 mm
107.154		Tubular nozzle Ø 5 mm, push-fit
107.006		Extension nozzle Ø 5 x 130 mm, straight
107.308		Sieve reflector 50 × 35 mm, push-fit
107.309		Sieve reflector 35 × 20 mm, push-fit
107.313		Spoon reflector 25 × 30 mm, push-fit
107.325		Soldering reflector 17 × 34 mm, push-fit
107.319		Sieve reflector Ø 65 mm
107.315		Folding reflector 70 × 12 mm, push-fit
107.007		De-horning nozzle
107.345		Welding mirror 135 mm, PTFE-coated
115.513		Heating element, 230 V / 1800 W



Contained in delivery



Shrinking of cable labels



Ergonomic design for strain-free car wrapping.

Hand tool

SONORA S1

The handy, quiet and compact tool for universal use. It is applied in fields as diverse as shrinking, vehicle labeling, forming and heating. Its balanced design allows for strain-free welding. Excellent price/performance ratio.

- Light and compact
- High stability in head-handle position for long term use
- Balanced ergonomics with soft grip
- Very quiet tool, ideal for indoor use
- Constant temperature and closed-loop controlled electronics

Technical Data







Voltage	V	230
Power	W	2000
Temperature	°C	80 – 650
Size	mm	230 x 200
Weight	kg	0.6 (without 2 m cord)

Article No.

140.996 SONORA S1, 230 V / 2000 W with Euro-plug

More versions on request

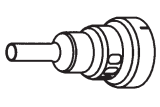
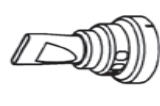
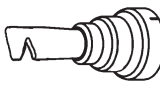
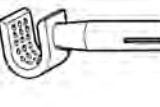
Accessories SONORA S1

119.269		Glass protection nozzle
119.270		Wide slot nozzle 50 mm
119.314		Reducer nozzle (Included in delivery)
119.271		Reflector nozzle (Included in delivery)
119.316		Tubular nozzle 5 mm
119.315		Wide slot nozzle 20 mm
119.312		Solder sleeve reflector nozzle (Included in delivery)
107.324		sieve reflector 12 x 10 mm
107.308		sieve reflector 50 x 35 mm



Welding of bitumen sheeting using the powerful ELECTRON with a wide slot nozzle.

Hand tool

ELECTRON

Powerful and versatile, the ELECTRON is the tool the specialist would wish for.

- Powerful
- Compact
- Robust
- Construction site tried and tested

Technical Data

Voltage	V~	230 / 400
Power	W	3400 / 5500
Frequency	Hz	50 / 60
Temperature	°C	20 – 650
Pressure static	Pa	3000 (30 mbar)
Size (L x Ø)	mm	320 x 95, handle Ø 64
Weight	kg	1.3 (without 3 m cord)
Marking of conformity	CE	
Approval Mark	Ⓢ	
Certification Scheme	CCA	
Protection Class II	□	

Article No.

107.781	ELECTRON 230V / 3400W with Euro plug
107.788	ELECTRON 400V / 5500W, with 16A CEE-Stecker
110.889	ELECTRON 120V / 2700W with 32A UK plug
116.055	ELECTRON 230V / 3400W with sprap nozzle, with Euro plug

More versions on request

Accessories ELECTRON









107.258		Wide slot nozzle, push-fit 70 x 10 mm, for bitumen
107.134		Wide slot nozzle, push-fit 40 x 2 mm, for bitumen
107.266		Wide slot nozzle 75 x 2 mm, push-fit, with tool stand (Artikel 116.753)
116.753		Tool stand
107.270		Wide slot nozzle 150 x 12 mm, push-fit
107.229		Round nozzle 20 mm
107.331		Folding reflector 70 x 70 mm, push-fit
107.327		Sieve reflector 85 x 85 mm, push-fit
107.333		Sieve reflector 150 x 130 mm, push-fit
107.340		Shell reflector, 45 x 250 mm, push-fit
107.328		Folding reflector 60 x 75 mm, push-fit

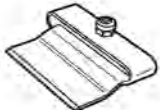

Accelerating the drying process of varnish, paint and body filler using the ELECTRON.



ELECTRON with scraper nozzle. Scraping color without solvent!

106.127		Sieve reflector Ø 65 mm
107.330		Folding reflector 125 x 22 mm, push-fit
116.054		Scraper nozzle, (only use in combination with heater tube, Article no. 116.053)
105.961		Wide slot nozzle 45 x 12 x 350 mm (for foundries)
107.347		Swordshaped nozzle 74 x 12 x 520 mm, edges rounded, PTFE-coated
107.346		Welding mirror 270 mm, push-fit
107.348		Tool rest
113.269		Heating element, 230 V / 3400 W
101.273		Heating element, 400 V / 5500 W



Flameless shrink-wrapping of pallets and bulky goods with the FORTE S3. This allows work to be carried out in closed spaces.

Hand tool

FORTE S3

The most powerful hand tool from Leister: FORTE S3 is extremely well suited to flameless shrinking of pallets and bulky goods.

- Powerful pallet-shrinking tool
- Uniform shrinkage
- May be used in the most confined spaces
- Integrated tool stand

Technical Data

Voltage	V~	3 x 230	3 x 400
Power	W	10000	10000
Frequency	Hz	50 / 60	
Temperature	°C	650	
Pressure static	Pa	1200 (12 mbar)	
Size (L x B x H)	mm	390 x 132 x 215	
Weight	kg	4.4 (without 10 m cord)	
Marking of conformity		CE	
Approval Mark		Ⓢ	
Certification Scheme		CCA	
Protection Class II		□	

Article No.

102.027 FORTE S3 3x400V / 10KW with 16A CEE plug

102.030 FORTE S3 3x230V / 10KW with 16A CEE plug

More versions on request



The HOTWIND S is perfectly suited for drying and firing-in of color on plastic components.

Hand tool

HOTWIND S

Weighing just 3.0 kg, the HOTWIND S can be used both as an integrated or bench device. This enormous flexibility combined with the high maximum temperature of up to 800°C and the wide range of accessories means that HOTWIND S can be used in a variety of ways.

- Ideal for warming, heating, forming and drying
- Heating power steplessly adjustable with potentiometer
- Integrated device and heating element protection
- Manual air slide, handle push-fit
- Extremely smooth running

Technical Data

Voltage	V~	230
Frequency	Hz	50 / 60
Power	W	3700
Max. exhaust temperature	°C	650 / 800
Pressure static	Pa	200 (2 mbar)
Weight	kg	3.0 (without 3 m cord)
Marking of conformity		CE
Approval Mark		Ⓢ
Certification Scheme		CCA
Protection Class II		□

Article No.

102.581 Hotwind S, 230V/3700W, with Euro-plug

More versions on request

Accessories HOTWIND S

<p>107.260 107.259 105.977 107.263 107.262 105.992 105.991</p>		<p>Wide slot nozzle, push-fit (a × b)</p> <p>85 × 15 mm 150 × 12 mm 200 × 9 mm 250 × 12 mm 300 × 4 mm 400 × 4 mm 500 × 4 mm</p>
<p>125.317</p>		<p>Flange connector, push-fit a = 90 mm</p>
<p>107.335</p>		<p>Sieve reflector, push-fit Ø 150 mm</p>
<p>107.248</p>		<p>Stainless steel filter, push-fit on air intake</p>
<p>102.362</p>		<p>Heating element, 230 V / 3600 W</p>

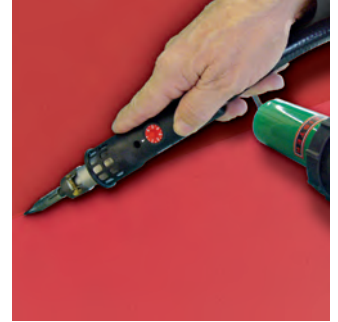

LABOR S, used in connection with MINOR as an external air supply.

Hand tool

LABOR S

Small but scrappy: The LABOR S is a jack of all trades. It can be used to weld even difficult to access locations perfectly. It causes almost no fatigue, even for small hands.

- Temperature adjustment via rotary knob
- Very small and light device
- Ideal for draw welding and tacking
- Air supply with ROBUST blower, MINOR or compressed air
- Ideal for mobile use when coupled with MINOR blower

Technical Data







Voltage	V~	230 / 120
Power	W	800 / 600 / 900
Frequency	Hz	50 / 60
Temperature	°C	20 – 600
Size (L x Ø)	mm	180, handle Ø 40
Weight	kg	0.15 (without air hose, without cord)
Marking of conformity		CE
Approval Mark		Ⓢ
Certification Scheme		CCA
Protection Class II		□

Article No.

- 101.716 LABOR S with connection box 230 V / 800 W with Euro-plug, Air hose 3 m
 101.723 LABOR S with junction box, 120V/600W, 3m PVC-hose, without plug
 101.754 LABOR with MINOR blower 230 V / 900 W with EURO plug, air hose 1.5 m

More versions on request

Accessories LABOR S

107.144		Tubular nozzle Ø 5 mm, push-fit
106.992 106.993		Speed weld nozzle, push-fit on Tubular nozzle Ø 5 mm
106.989 106.990 106.991		5.7 mm, profile A 7 mm, profile B
106.996		Tacking nozzle, push-fit on Tubular nozzle Ø 5 mm
101.581		Heating element, 230 V / 800 W
101.643		Heating element, 120 V / 600 W

WELDING PEN R



WELDING PEN S



The rotating air hose on the WELDING PEN facilitates work.



Wire welding using the compact, light WELDING PEN R.

Hand tool

WELDING PEN R / WELDING PEN S

The WELDING PEN is an optimized hand tool for draw welds. Due to its slim design and the external air supply by a swiveling air hose work becomes nearly fatigue-free.

The closed-loop controlled WELDING PEN R provides the perfect welding temperature, which is shown on the display and can be adjusted easily. High quality work may also be carried out using the WELDING PEN S which is easily controlled by means of the rotary knob.

- Used in combination with ROBUST blower or compressed air
- Digital temperature display (WELDING PEN R)
- Swiveling air hose connection
- Cooled heating element tube

Technical Data

Voltage	V~	230 / 120
Power	W	1000 / 600
Frequency	Hz	50 / 60
Temperature	°C	20 – 600
Size (L x Ø)	mm	270 x 43, handle Ø 32
Weight	kg	1.0 (with 3 m cord / air hose and Y-connection)







Marking of conformity	CE
Approval Mark	Ⓢ
Certification Scheme	CCA
Protection Class II	□

Article No.

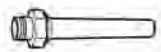
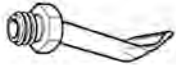
114.380	WELDING PEN R, 230V / 1000W, screw-on, with Euro-plug
119.966	WELDING PEN R, 120V / 600W, screw-on, with UK-plug
113.081	WELDING PEN S, 230V/1000W, screw-on, with Euro-plug
114.275	WELDING PEN S, 120V/600W, screw-on, with UK-plug

More versions on request

Accessories WELDING PEN R / WELDING PEN S

105.622		Tubular nozzle Ø 5 mm, push-fit
106.988		Tacking nozzle, screw-on
113.666 113.399		Drawing nozzle round, Ø 3 mm Drawing nozzle round, Ø 4 mm, with tacking tip, screw-on
113.876 113.874		Drawing nozzle round, Ø 3 mm Drawing nozzle round, Ø 4 mm, without tacking tip, screw-on
113.670		Triangular drawing nozzle, with tacking tip, screw-on, 90 – 5.7 mm
113.877 106.986		Triangular drawing nozzle, without tacking tip, screw-on 5.7 mm, profile A 7 mm, profile B
106.987		7 x 5.5 mm
126.552		drawing nozzle Ø 4 mm, screw-on for Fluor plastics
127.726 127.727		Angular adapter for screw-on nozzles, screw-on 30° 45°
113.412		Heating element for WELDING PEN R and WELDING PEN S, 230 V / 1000 W
113.597		Heating element for WELDING PEN R and WELDING PEN S, 120 V / 600 W

DIODE PID



DIODE S



Convenient wire welding using the powerful, light DIODE PID.



PP-Container, Colasit, Switzerland

Hand tool

DIODE PID / DIODE S

The DIODE is an extremely handy high performance tool. The closed-loop controlled DIODE PID provides the perfect welding temperature at all times. Due to its display, adjusting the temperature is simple. High quality work may also be carried out using the DIODE S which is easily controlled by means of a rotary knob.

- Operated with ROBUST blower or compressed air
- Digital controlled and displayed temperatures (WELDING PEN R)
- Cooled heating element tube
- In combination with MINOR blower suitable for field applications

Technical Data

Voltage	V~	230 / 120
Frequency	Hz	50 / 60
Power	W	1600
Temperature	°C	20 – 600
Min. air flow (20° C)	l/min	40
Size (L x Ø) mm		265 x 57, handle Ø 40
Weight	kg	1.15 (with 3 m cord / 3 m air hose)
Marking of conformity		CE
Approval Mark		Ⓢ
Certification Scheme		CCA
Protection Class II		□

Article No.

- 101.303 DIODE PID,230V/1600W push-fit with Euro-plug
- 101.304 DIODE PID,230V/1600W, screw-on with Euro-plug
- 101.313 DIODE PID 120V/1600W for push-fit nozzles, with UK-plug yellow
- 101.281 DIODE S, 230V,/1600Wpush-fit with Euro-plug
- 101.282 DIODE S,230V/1600W, screw-on with Euro-plug
- 101.293 DIODE S 120V/1600W for push-fit nozzles, with UK-plug yellow

More versions on request

Accessories DIODE PID / DIODE S

With push-fit nozzle

100.303		Tubular nozzle Ø 5 mm, for versions with nozzles, push-fit
105.578		Version extra-strong
106.992 106.993		Speed weld nozzle, push-fit on Tubular nozzle Ø 5 mm
106.989 106.990 106.991		5.7 mm, profile A 7 mm, profile B
106.996		Tacking nozzle, push-fit on Tubular nozzle Ø 5 mm
107.348		Tool rest
100.296		Heating element for DIODE PID, 230 V / 1550 W
100.689		Heating element for DIODE S, 230 V / 1550 W

With screw-on nozzle

105.622		Tubular nozzle Ø 5 mm, screw-on
106.988		Tacking nozzle, screw-on
113.666 113.399		Drawing nozzle round, Ø 3 mm Drawing nozzle round, Ø 4 mm, with tacking tip, screw-on
113.876 113.874		Drawing nozzle round, Ø 3 mm Drawing nozzle round, Ø 4 mm, without tacking tip, screw-on
113.670		Triangular drawing nozzle, with tacking tip, screw-on, 90 – 5.7 mm
113.877 106.986 106.987		Triangular drawing nozzle, without tacking tip, screw-on 5.7 mm, profile A 7 mm, profile B 7 x 5.5 mm
126.552		Drawing nozzle, 4mm, screw-on, for Fluor plastics



MINOR blower with DIODE PID



MINOR blower as an air supplier for the DIODE PID

Blower

MINOR

Don't be deceived by the MINOR's small size and low weight: This blower delivers sufficient air to enable quality work with DIODE PID / S or LABOR S.

- Light and compact
- Powerful
- Serves as mobile air supply for the hand tools DIODE PID / S and LABOR S
- Also suitable for work on construction sites

Technical Data

Voltage	V~	230
Power	W	100
Frequency	Hz	50 / 60
Air flow (20°C)	l/min	400
Pressure static	Pa	4000 (40 mbar)
Air outlet (external)	mm	14.5
Size (L x Ø)	mm	250 x 95, handle Ø 64
Weight	kg	1.15 15 (with 3 m cord)
Marking of conformity	CE	
Approval Mark	E	
Certification Scheme	CCA	
Protection Class II	□	

Article No.

- 108.747 Minor, 230V/100W, with Euro-plug
- 109.988 Minor, 120V/100W, with UK-plug yellow

More versions on request



Blower ROBUST, serving as external air supply for the WELDING PEN.



Blower

ROBUST

Versatile and operable at high ambient temperatures of up to 60°C. Despite its small dimensions, the ROBUST is a real powerhouse. It offers great flexibility thanks to its extensive range of accessories.

- Compact design– high performance
- Sound-suppressed
- Can be fitted at any position
- Serves as an external air supply for 3 DIODEN PID / S, 1 WELDING PEN R / S and 3 LABOR S

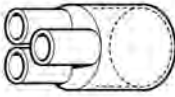
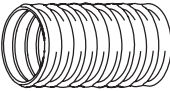
Accessories ROBUST

107.354		Stainless steel filter, push-fit on Air intake
107.281		Hose connection adapter (Ø 38 mm), 3 Output every 14 mm
113.859		Air hose Ø 14 mm
101.031		hose clip for air hose Ø 14 mm

Technical Data

Voltage	V~	230
Power	W	250
Frequency	Hz	50 / 60
Air flow (20°C)	l/min	1200 / 1300
Pressure static	Pa	8000 / 10 500 (80 / 105 mbar)
Ambient temperature	°C	< 60
Protection type (IEC 60529)		IP 54
Air intake (external)	mm	Ø 38
Air outlet (external)	mm	Ø 38
Weight	kg	8.0 (with 3 m cord)
Size (L x B x H)	mm	255 x 221 x 221
Marking of conformity		CE
Protection Class I		⊕

Article No.









103.432 Blower ROBUST 1 x 230 V with condenser und 3 m cord with Euro-plug

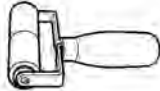

Hand tools

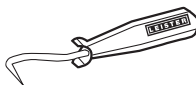





General Accessories

Roofing

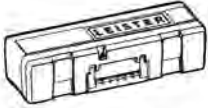

140.160		Pressure roller 40 mm with ball bearings, (Silicone)
140.161		Pressure roller 28 mm with ball bearings, (Silicone)
106.974		Pressure roller 80 mm (Silicone)
106.972		Pressure roller 80 mm (Silicone)
106.976		Pressure roller 28 mm (PTFE)
138.314		Seam probe tester
111.346		Edge plane with 10 spare blades
111.348		spare blades kit containing 10 blades
137.855		Leister-Cutter with 4 spare blades
116.586		Transport box, for TRIAC BT, TRIAC PID, TRIAC S, ELECTRON

Billboards / Tarpaulins

106.974		Pressure roller 80 mm (Silicone)
---------	---	----------------------------------



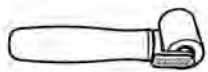
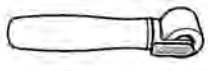

140.160		Pressure roller 40 mm with ball bearings, (Silicone)
140.161		Pressure roller 28 mm with ball bearings, (Silicone)
106.981		Pressure roller for customs seal roller
137.855		Leister-Cutter with 4 spare blades
116.586		Transport box, for TRIAC BT, TRIAC PID, TRIAC S, ELECTRON
116.798		Brass brush

Civil Engineering / Tunnel / Landfill sites

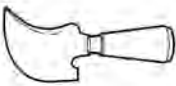

140.160		Pressure roller 40 mm with ball bearings, (Silicone)
140.161		Pressure roller 28 mm with ball bearings, (Silicone)
106.976		Pressure roller 28 mm (PTFE)

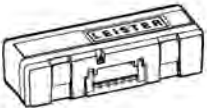

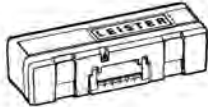
Container and apparatus construction

107.348		Tool rest (TRIAC)	106.969		Spatula
137.855		Leister-Cutter with 4 spare blades	137.855		Leister-Cutter with 4 spare blades
116.586		Transport box, for TRIAC BT, TRIAC PID, TRIAC S, ELECTRON	106.966		Hand grooving tool
			106.968		Spare blades for hand grooving tool
			116.586		Transport box, for TRIAC BT, TRIAC PID, TRIAC S, ELECTRON

Floorings / Interior decoration

122.541		Trimming guide
106.972		Pressure roller, with ball bearings (Brass)
106.974		Pressure roller 80 mm (silicone)
140.160		Pressure roller 40 mm with ball bearings, (Silicone)
140.161		Pressure roller 28 mm with ball bearings, (Silicone)
106.976		Pressure roller 28 mm (PTFE)



Welding rods

Article		packaging units (kg)
Welding accessories PE		
104.283	Welding rod HDPE, profile A, black	3
104.294	Welding rod HDPE, profile A, white	3
104.284	Welding rod HDPE, profile B, black	5
104.299	Welding rod HDPE, profile B, white	5
106.650	Welding band HDPE, 8x2mm, white	1
104.300	Welding rod LDPE, profile A, black	3
Welding accessories PP		
104.287	Welding rod PP, profile A, grey/beige	3
104.301	Welding rod PP, profile A, black	3
104.288	Welding rod PP, profile B, grey/beige	5
126.356	Welding band PP, 8x2mm, natural	1
Welding accessories PVC		
104.296	Welding rod PVC-U(hart), profile A, transparent	3
104.278	Welding rod PVC-U(hart), profile A, grey	3
106.641	Welding rod PVC-U, profile A, brown	3
104.280	Welding rod PVC-U(hart), profile B, brown	5
104.279	Welding rod PVC-U(hart), profile B, grey	5
104.302	Welding rod PVC-P(weich), profile A, transparent	3
Welding accessories ABS		
104.295	Welding rod ABS, profile A, white	5
113.587	Welding rod ABS, profile A, black	3
107.027	Welding band ABS, 8x2mm, white	1

Article		packaging units (kg)
Welding accessories div.		
104.297	Welding rod PA, profile A, black	3
104.298	Welding rod PC, profile A, transparent	3
104.313	Welding rod PC/ABS/ALPHA (Honda), profile A, black	3
104.311	Welding rod PC/PBTP (Xenoy), profile A, grey	3
104.309	Welding rod PS, profile A, white	3
104.308	Welding rod PUR, profile A, black	3
106.654	Welding band Xenoy, 8x 2mm, grey	1
106.642	Welding rod PPs, profile A, grey, flame resistant	3
104.304	Welding rod PVDF, profile A, natural	3
104.303	Welding rod POM, profile A, natural	3
Test bundles		
107.036	Test bundle bodywork welding rods, each consisting of profile A pieces of 37 mm. single marked 6x HDPE, 6x PP, 6x PA, 6x PC, 6x ABS, 6x PCABS/APLHA Honda, 6x PC/PBTP/Xenoy	
107.037	Test bundles standard each consisting of profile A pieces of 37 mm. single marked 5x PVC-U, 5x PVC-P, 5x PP, 5x ABS, 5x HDPE, 3x PC, 3x PA, 3x POM, 3x LDPE, 3x PC/ABS/ALPHA Honda, 3x PC/PBTP/Xenoy	
107.040	Test bundle welding band each consisting of profile A pieces of 37 mm. single marked 9x HDPE 8x2mm white, 9x PP, 8x 2mm natural, 9x ABS 8x 2mm white, 9x PC/PBTP/Xenoy grey	

Profile sizes

Profile A		Diameters in mm
Profile B		