



CSS EASY

CSS

KSR DIGITAL



CSS EASY



CSS



KSR DIGITAL

Leister Process Technologies
Galileo-Strasse 10
CH-6056 Kaegiswil/Switzerland
Tel. +41-41662 74 74
Fax +41-41662 74 16
www.leister.com
sales@leister.com

Operating Instructions



Please read operating instructions carefully before use and keep for further reference.

Leister CSS EASY / CSS / KSR DIGITAL Temperature controller

SOFTWARE-VERSION 3.10
Issue operating instructions 05.2008



Warning



Danger! When opening up the tool, live components and connections are exposed. The mains plug must be removed from the main socket before opening the tool. **Caution separate source voltage.**



Caution



The **voltage rating** stated on the tool must correspond to the mains voltage.



Protect tool from **damp** and **wet**.

Service and Repair

Repairs should only be carried out by authorised **Leister Service Centres**. They guarantee a correct and reliable **repair service within 24 hours** using original spare parts in accordance with the circuit diagrams and spare parts lists.

Warranty

For this tool, we generally provide a warranty of one (1) year from the date of purchase (verified by invoice or delivery document). Damage that has occurred will be corrected by replacement or repair.

Additional claims shall be excluded, subject to statutory regulations.

Damage caused by normal wear, overloading or improper handling is excluded from the guarantee.

Guarantee claims will be rejected for tools that have been altered or changed by the purchaser.

Conformity

Leister Process Technologies, Galileo-Strasse 10, CH-6056 Kaegiswi/Switzerland confirms that this product, in the version as brought into circulation through us, fulfils the requirements of the following EC directives.

Directives: 2004/108, 2006/95

Harmonized Standards: EN 61326-1, EN 61000-3-2, EN 61000-3-3, EN 61000-6-2, EN 61000-6-4, EN 61010-1,

Kaegiswil, 20.06.2008

Christiane Leister Christiane Leister, Owner

Disposal



Power tools, accessories and packaging should be sorted for environmental-friendly recycling. **Only for EC countries:** Do not dispose of power tools into household waste! According to the European Directive 2002/96/EC on waste electrical and electronic equipment and its incorporation into national law, power tools that are no longer suitable for use must be separately collected and sent for recovery in an environmental-friendly manner.

INSTALLATION

Dimensions and cut-out; panel mounting

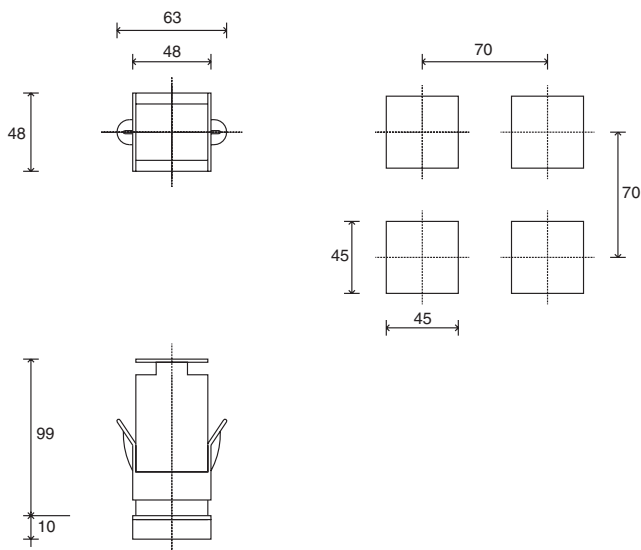

For correct and safe installation, follow the instructions and observe the warnings contained in this manual.

PANEL MOUNTING:

To fix the unit, insert the brackets provided into the seats on either side of the case. To mount two or more units side by side, respect the cut-out dimensions shown in the drawing.

APPLICATION: The regulator is intended for industrial applications compliant with EN 61000-6-2 and EN 61000-6-4.

MAINTENANCE: The device is maintenance-free.

Do not clean the case with hydrocarbon-based solvents (Petrol, Trichlorethylene, etc.). Use of these solvents can reduce the mechanical reliability of the device. Use a cloth dampened in ethyl alcohol or water to clean the external plastic case.

SERVICE: LEISTER has its own service department.

TECHNICAL SPECIFICATIONS

Display	2 x 4 digits, 7-segment-LED display, green, height 10 and 7mm
Keys	4 mechanical keys (Man/Aut, INC, DEC, F)
Accuracy	0.2% full scale \pm 1 digit at 25°C room temperature
Main input (settable digital filter)	TC, RTD, PTC, NTC 60mV, 1V Ri \geq 1M Ω ; 5V, 10V Ri \geq 10K Ω ; 20mA Ri=50 Sampling time 120 msec.
Type TC Thermocouples (ITS90)	Type TC Thermocouples : J,K,R,S,T (IEC 584-1, CEI EN 60584-1, 60584-2) ; custom linearization is available / types B,E,N,L GOST,U,G,D,C are available by using the custom linearization.
Cold junction error	0,1° / °C
RTD type (scale configurable within indicated range, with or without decimal point) (ITS90) Max line resistance for RTD	DIN 43760 (Pt100), JPT100 20 Ω
PTC / NTC	990 Ω 25°C / 1K Ω 25°C
Safety	detection of short-circuit or opening of probes, LBA alarm, HB alarm
°C / °F selection	configurable da tastiera/configurable from faceplate
Linear scale ranges	-1999 to 9999 with configurable decimal point position
Controls	PID, Self-tuning, on-off
pb - dt - it	0,0...999,9 % - 0,00...99,99 min - 0,00...99,99 min
Action	Heat
Control outputs	on / off, continuous
Maximum power limit heat	0,0...100,0 %
Cycle time	0...200 sec
Main output type	relay, logic, continuous (0...10V / 4...20mA)
Softstart	0,0...500,0 min
Fault power setting	0,0...100,0 %
Standby-funktion	Actual value display, controller deactivated
3 Configurable alarms	Up to 3 alarm functions assignable to an output, configurable as: maximum, minimum, symmetrical, absolute/deviation, LBA, HB
Alarm masking	- exclusion during warm up - latching reset from faceplate or external contact
Type of relay contact	NO (NC), 5A, 250V/30Vdc cos ϕ =1
Logic output for static relays	24V \pm 10% (10V min zu 20mA)
Transmitter power supply	15/24VDC, max 30mA short-circuit protection
Analogue retransmission signal	10V/20mA Flood max 720 Ω resolution 12 Bit
Power supply (switching type)	100... 240 V AC \pm 10% 50/60 Hz, max. 8VA
Faceplate protection	IP65
Working / Storage temperature range	0...50°C / -20...70°C
Relative humidity	20...85% nicht kondensierend
Environmental conditions of use	for internal use only, altitude up to 2000m
Installation	Panel, plug-in from front
Weight CSS EASY	450 g
CSS	200 g
KSR Digital	450 g

EMC conformity has been tested with the following connections

FUNCTION	CABLE TYPE	CABLE LENGTH
Power supply cable	1 mm ²	1 m
Relay output cable	1 mm ²	3,5 m
TC input	0,8 mm ² compensated	5 m
Pt100 input	1 mm ²	3 m

Device structure

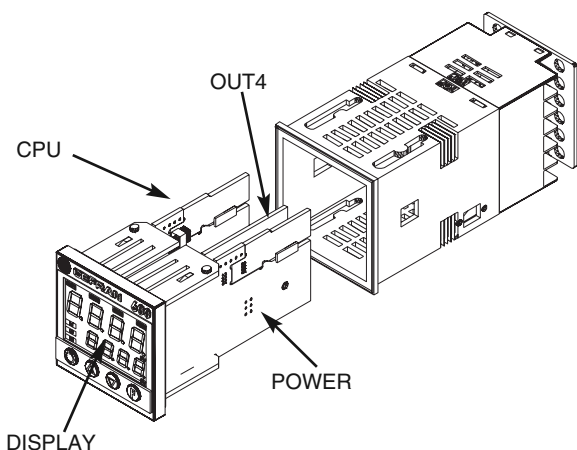

Identification of boards

POWER- board

Select transmitter voltage

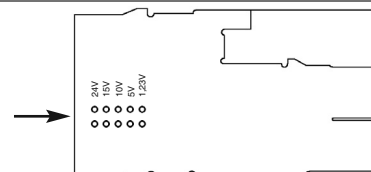

OUT4-board

S open
Power output signal
S closed
Voltage output signal

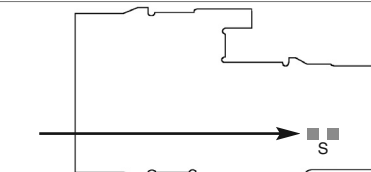

CPU- board

Select signal at contact 3

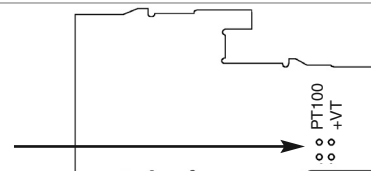

CSS EASY

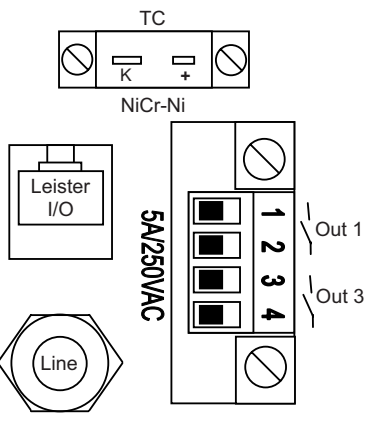
TC

NiCr-Ni

Leister I/O

5A/250VAC

Line

Out 1

Out 3

CSS

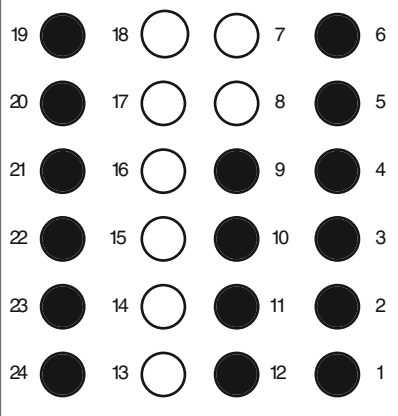
19 18 7 6

20 17 8 5

21 16 9 4

22 15 10 3

23 14 11 2

24 13 12 1

KSR DIGITAL

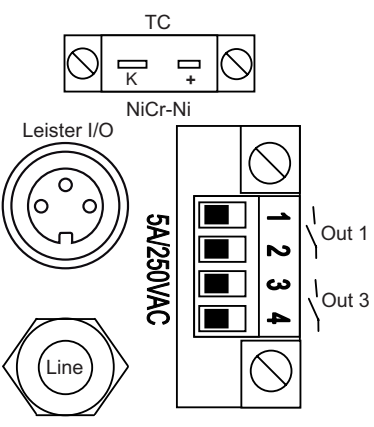
TC

NiCr-Ni

Leister I/O

5A/250VAC

Line

Out 1

Out 3

Connector pin assignment CSS

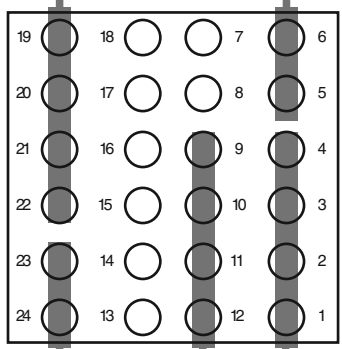
Alarm output 1 + 2 / Logic output			Inputs	
Configurable output - Logic 24V, 10V zu 20mA - Relais 5A zu 250Vac/30Vdc (Alarm output 1) - Relais 5A zu 250Vac/30Vdc (Alarm output 2)			• TC Available thermocouples: J, K, R, S, T (B, E, N, L, U, G, D, C custom linearization is available) - Observe polarities - For extensions, use the correct compensating cable for the type of TC used	
Power Supply 100 ... 240 VAC ± 10%			• Linear input for 3-wire transmitter Connect at 20mA input	
outputs - Feeding voltage 24 VDC for Leister-SYSTEM -Elektronik - Output signal 4 – 20 mA (0 – 20 mA / 0 – 10 VDC)			• Linear signal (I) Linear input in dc current 20mA, Ri = 50	
		• Linear input for 3-wire transmitter 4...20mA		
		• Linear signal (V) Linear input in dc voltage! 60mV, 1V Ri > 1M 5V, 10V Ri > 10K		
		• Pt100 / PTC / NTC Use wires of adequate diameter (min. 1mm²) PT100, JPT100, PTC, NTC		

DESCRIPTION OF FACEPLATE

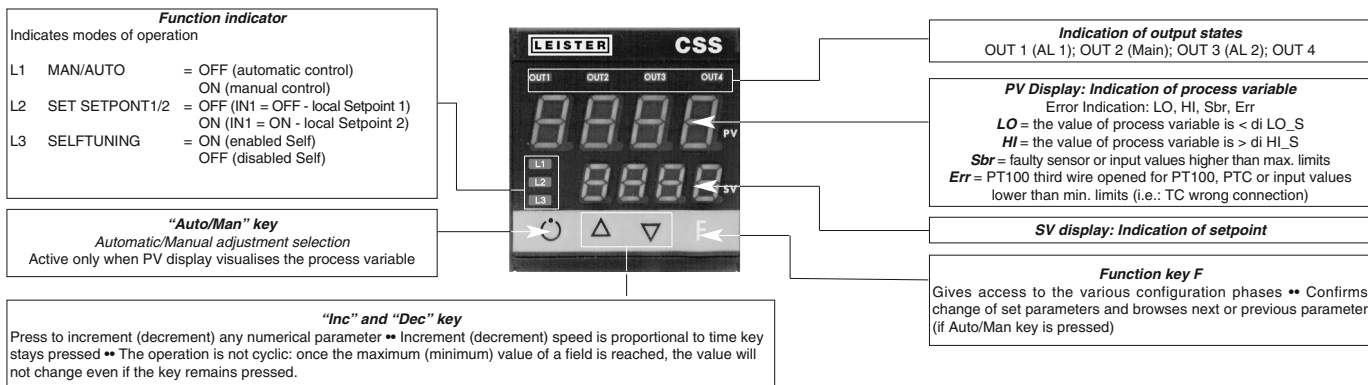

SOFTWARE ADJUSTMENT

The temperature regulator is supplied by Leister Process Technologies with pre-programmed default settings. These settings can be adjusted by the user if required (temperature input, control behaviour, etc.).

The values of the default settings are noted under the relevant menu item and apply to all CSS EASY and CSS.

KSR-DIGITAL have type-specific settings that can be requested from Leister Process Technologies.

PROGRAMMING and CONFIGURATION

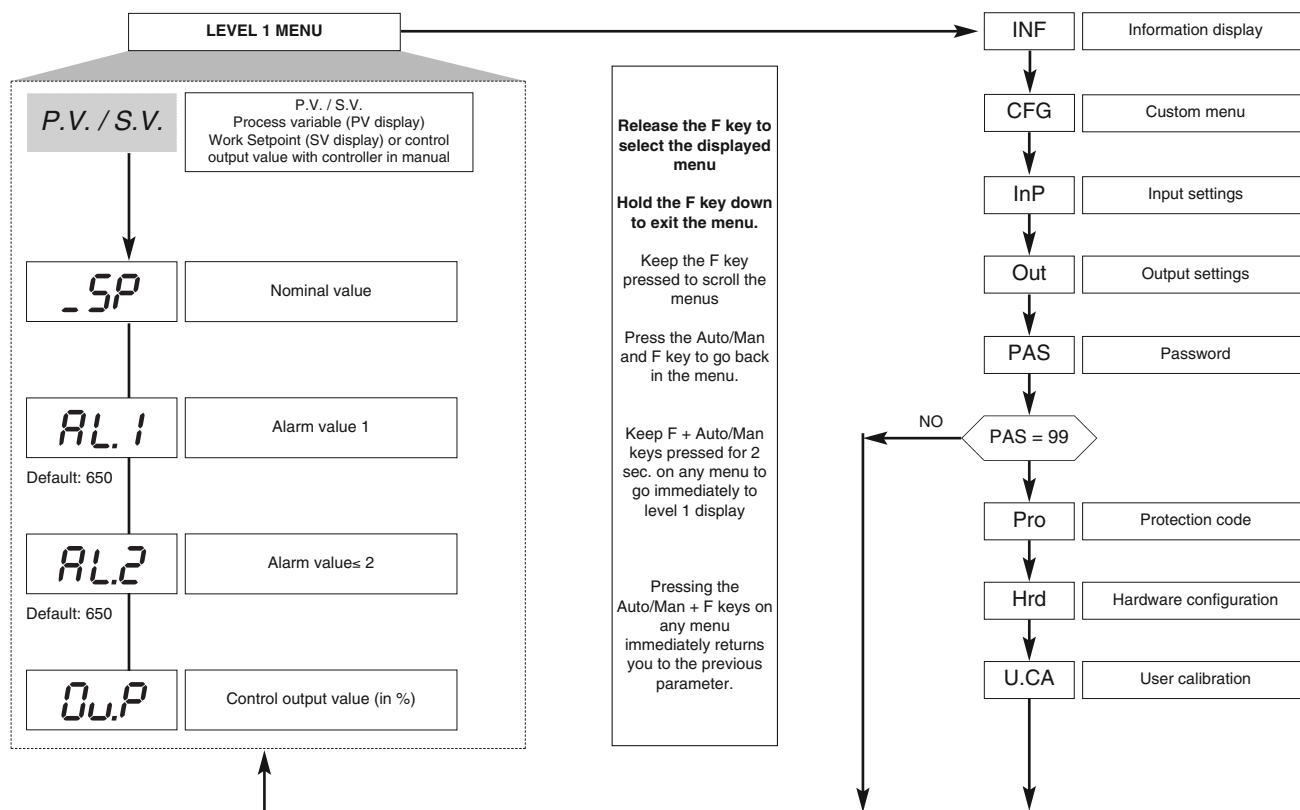

N.B.: Once a particular configuration is entered, all unnecessary parameters are no longer displayed

Information menu

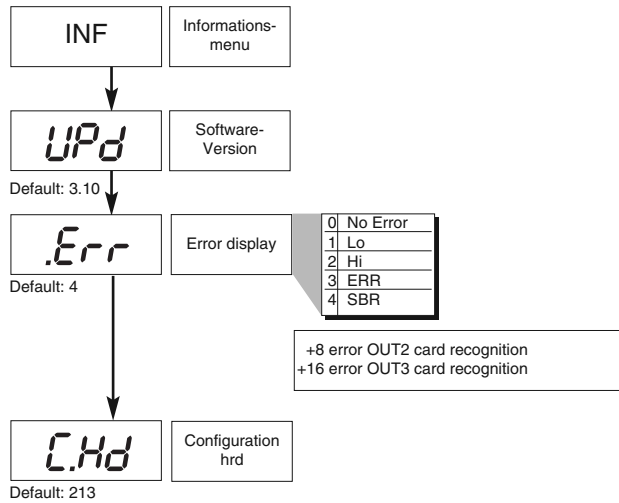

CFG menu

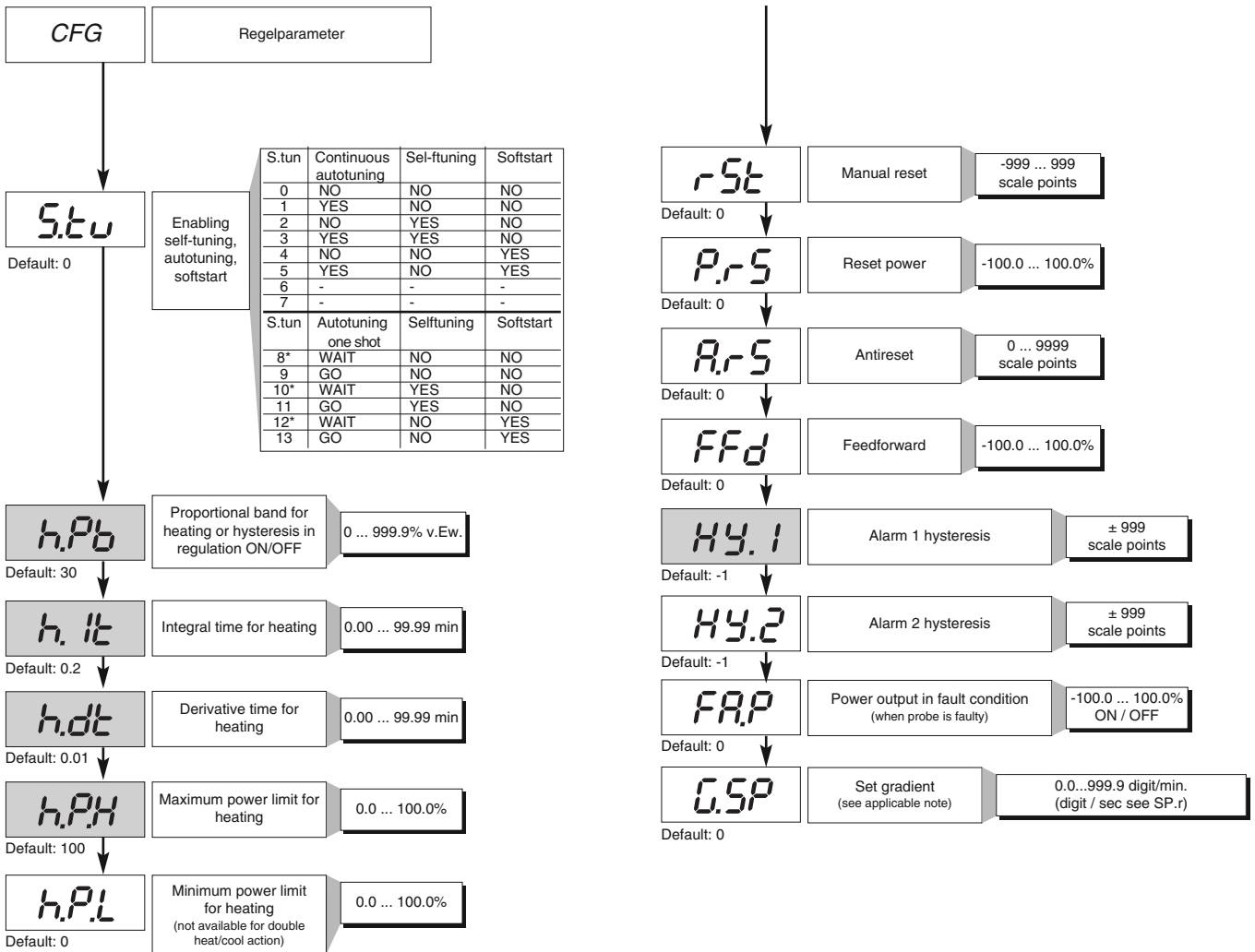

InP Menu

InP Input settings

SP Def. remote setpoint

Val.	Type of remote setpoint	Absolute Relative
0	Digital (from serial line)	Absolute
1	Digital (from serial line)	Relative to local setpoint

Default: 0

+2 set gradient in digit / sec

tyP Probe type, signal, enable custom linearization, and main input scale

Default: 2

Type	Probe type	without decimal point	with decimal point
	Sensore:	TC	
0	TC J °C	0/1000	0.0/999.9
1	TC J °F	32/1832	32.0/999.9
2	TC K °C	0/1300	0.0/999.9
3	TC K °F	32/2372	32.0/999.9
4	TC R °C	0/1750	0.0/999.9
5	TC R °F	32/3182	32.0/999.9
6	TC S °C	0/1750	0.0/999.9
7	TC S °F	32/3182	32.0/999.9
8	TC T °C	-200/400	-199.9/400.0
9	TC T °F	-328/752	-199.9/752.0
28	TC	CUSTOM	CUSTOM
29	TC	CUSTOM	CUSTOM
30	PT100 °C	-200/850	-199.9/850.0
31	PT100 °F	-328/156.2	-199.9/999.9
32	JPT100 °C	-200/600	-199.9/600.0
33	JPT100 °F	-328/1112	-199.9/999.9
34	PTC °C	-55/120	-55.0/120.0
35	PTC °F	-67/248	-67.0/248.0
36	NTC °C	-10/70	-10.0/70.0
37	NTC °F	14/158	14.0/158.0
38	0...60 mV	-1999/9999	-199.9/999.9
39	0...60 mV	Custom scale	Custom scale
40	12...60 mV	-1999/9999	-199.9/999.9
41	12...60 mV	Custom scale	Custom scale
42	0...20 mA	-1999/9999	-199.9/999.9
43	0...20 mA	Custom scale	Custom scale
44	4...20 mA	-1999/9999	-199.9/999.9
45	4...20 mA	Custom scale	Custom scale
46	0...10 V	-1999/9999	-199.9/999.9
47	0...10 V	Custom scale	Custom scale
48	2...10 V	-1999/9999	-199.9/999.9
49	2...10 V	Custom scale	Custom scale
50	0...5 V	-1999/9999	-199.9/999.9
51	0...5 V	Custom scale	Custom scale
52	1...5 V	-1999/9999	-199.9/999.9
53	1...5 V	Custom scale	Custom scale
54	0...1 V	-1999/9999	-199.9/999.9
55	0...1 V	Custom scale	Custom scale
56	200mv..1V	-1999/9999	-199.9/999.9
57	200mv..1V	Custom scale	Custom scale
58	Cust10 V-20mA	-1999/9999	-199.9/999.9
59	Cust10 V-20mA	Custom scale	Custom scale
60	Cust 60mV	-1999/9999	-199.9/999.9
61	Cust 60mV	Custom scale	Custom scale
62	PT100-JPT	CUSTOM	CUSTOM
63	PTC	CUSTOM	CUSTOM
64	NTC	CUSTOM	CUSTOM

For custom linearization:
 - LO signal is generated with variable below Lo.S or at minimum calibration value
 - HI signal is generated with variable above Lo.S or at maximum calibration value

FLt Digital filter on input (if = 0 excludes averaging filter on sample value)

Default: 0.1

0.0 ... 20.0 s

FLd Digital filter on input display

Default: 0.5

0 ... 9.9 scale points

dP.S Decimal point position for input scale

Default: 0

dP	S	Format
0		xxxx
1		xxx.x
2		xx.xx (*)
3		x.xxx (*)

(*) not available for TC, RTD, PTC and NTC scales

Lo.S Minimum limit of main input scale

Default: 0

min...max input range selected in tyP

Hi.S Maximum limit of main input scale

Default: 1300

min...max input range selected in tyP

oFS. Offset correction of main input

Default: 0

-999 ... 999 scale points

Lo.L Lower limit for setting SP and absolute alarms

Default: 0

Lo.S ... Hi.S

Hi.L Upper limit for setting SP and absolute alarms

Default: 650

Lo.S ... Hi.S

Out Menu

Out Output settings

ALr Select reference signal for alarm 1
Default: 0

A2r Select reference signal for alarm 2
Default: 0

AL.1.r, AL.2.r		
AL.x.r	Variable to be compared	Reference setpoint
0	PV (Process variable)	AL
1	SSP (active setpoint)	AL (only absolute)
2	PV (process variable)	AL (only relative and referred to SP1 with multiset function)]

ALt Alarm type 1
Default: 0

A2t Alarm type 2
Default: 0

AL.1.t, AL.2.t			
AL.x.t	Direct (high limit) Inverse (low limit)	Absolute or relative to active setpoint	Normal Symmetrical (window)
0	direct	absolute	normal
1	inverse	absolute	normal
2	direct	relative	normal
3	inverse	relative	normal
4	direct	absolute	symmetrical
5	inverse	absolute	symmetrical
6	direct	relative	symmetrical
7	inverse	relative	symmetrical

+8 to disable on power up until first interception
 +16 to latch alarm
 +32 Hys becomes delay time when alarm trips (0...999 sec.) (excluding symmetrical absolute)
 +64 Hys becomes delay time when alarm trips (0...999 min.) (excluding symmetrical absolute)

rL1 Out 1 Allocation of reference signa
Default: 2

rL2 Out 2 Allocation of reference signal
Default: 5

rL3 Out 3 Allocation of reference signal
Default: 3

rL.o.1, rL.o.2, rL.o.3, rL.o.4	
Val	Function of main output relay/logic (OUT1)
0	HEAT (control output for heating)
1	COOL (control output for cooling)
2	AL1 - alarm 1
3	AL2 - alarm 2
4	AL3 - alarm 3
5	ALHB - alarm HB
6	LBA - alarm LBA
7	IN1 - repetition of logic input
8	Repeat but key (if but = 8)
9	AL1 or AL2
10	AL1 or AL2 or AL3
11	AL1 and AL2
12	AL1 and AL2 and AL3
13	AL1 or ALHB
14	AL1 or AL2 or ALHB
15	AL1 and ALHB
16	AL1 and AL2 and ALHB

+32 for denied logic level at output, except codes 0...1 with continuous output

rEL Fault action (sets state in case of probe fault)
Err, Sbr
Default: 0

rEL	Alarm 1	Alarm 2	Alarm 3
0	OFF	OFF	OFF
1	ON	OFF	OFF
2	OFF	ON	OFF
3	ON	ON	OFF
4	OFF	OFF	ON
5	ON	OFF	ON
6	OFF	ON	ON
7	ON	ON	ON

An.o Out W Assignment of signal or reference value
Default: 5

Val	Reference value
0	PV - process variable
1	SSP - active setpoint
2	SP - local setpoint
3	-
4	Deviation (SSP-PV)
5	HEAT (*)
6	COOL (*)
7	AL1 (alarm point)
8	AL2 (alarm point)
9	AL3 (alarm point)
10	-
11	Value acquired from serial line (*)

16 for code 0 if input is in error status Err - Sbr output assumes minimum trimming value.

Prot menu (PAS)

Pro Protection code (PAS 99)

Prot	Display	Modification
0	SP, In2, alarms, OuP, INF	SP, alarms
1	SP, In2, alarms, OuP, INF	SP
2	SP, In2, OuP, INF	

+4 to disable InP, Out
 +8 to disable CFG, Ser,
 +16 to disable SW "power-up - power down"
 +32 disable manual power latching
 +64 to disable manual power modification
 +128 enables full configuration

Hrd menu

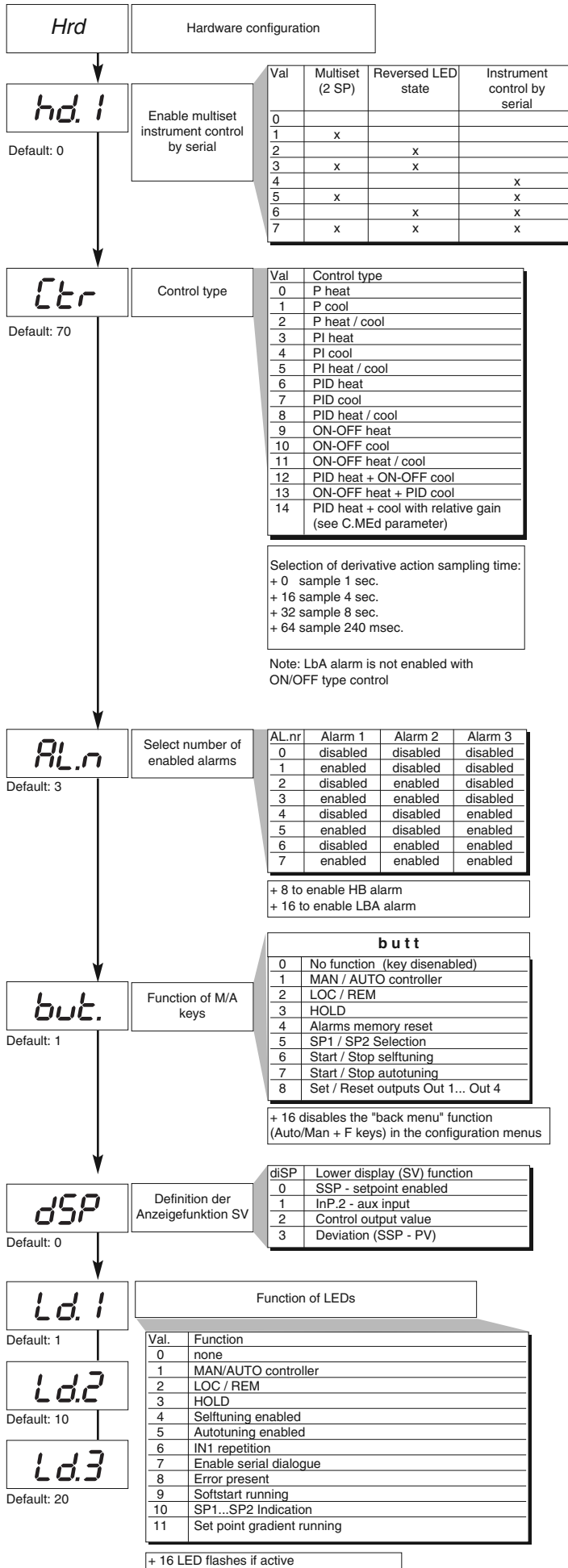

U.CAL menu

U.CA

Default: 0

User calibration

Val	Function
1	Analogue output (1)
2	Input 1 - custom 10V / 20mA
3	Input 1 - custom 60mV
4	Custom PT100 / J PT100
5	Custom PTC
6	Custom NTC
7	Input 2 - custom TA (2)

- (1) The analog output in 20mA is calibrated with accuracy higher than 0.2 % f.s.; calibrate when converting to 10V output.
- (2) In the absence of calibration, accuracy is higher than 1% f.s.; calibrate only if higher accuracy is required.

ALARMS

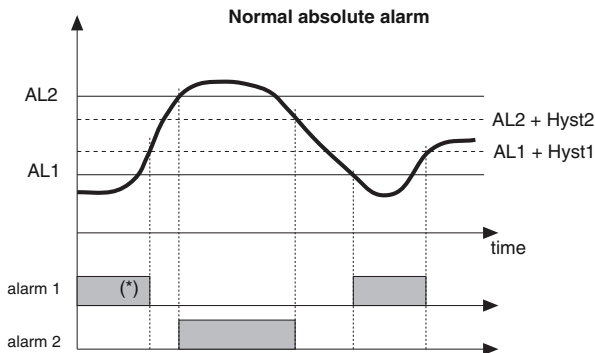

For AL1 = reverse absolute alarm (low) with positive Hyst1, AL1 t = 1
 (*) = OFF if disabled on power-up
 For AL2 = direct absolute alarm (high) with negative Hyst2, AL2 t = 0

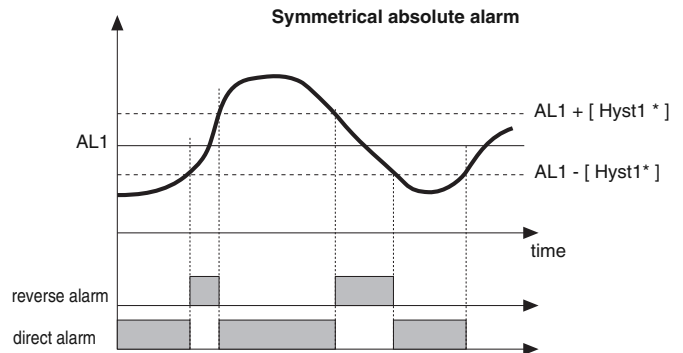

For AL1 = symmetrical Lo absolute alarm with Hyst1, AL1 t = 5
 For AL1 = symmetrical Hi absolute alarm with Hyst1, AL1 t = 4

* Minimum hysteresis = 2 scale points

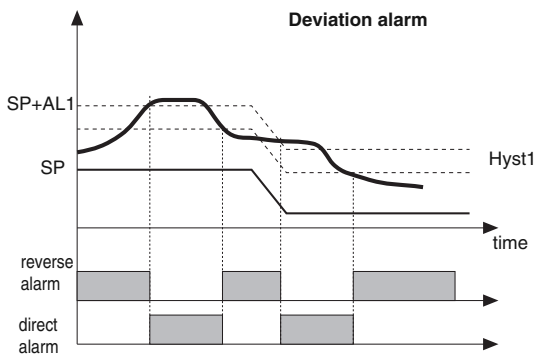

For AL1 = Lo deviation alarm with negative Hyst 1, AL1 t = 3
 For AL1 = Hi deviation alarm with negative Hyst 1, AL1 t = 2

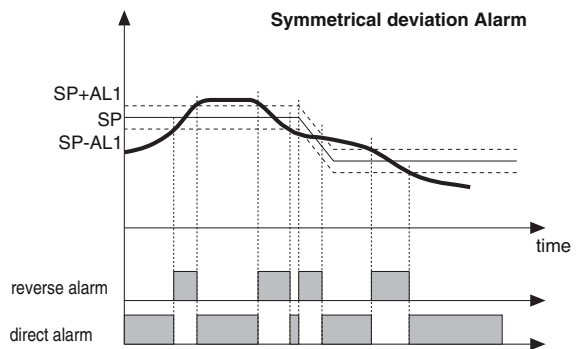

For AL1 = Symmetrical Lo deviation alarm with Hyst 1, AL1 t = 7
 For AL1 = Symmetrical Hi deviation alarm with Hyst 1, AL1 t = 6

CONTROL ACTIONS

Proportional Action:

action in which contribution to output is proportional to deviation at input (deviation = difference between controlled variable and setpoint).

Derivative Action:

action in which contribution to output is proportional to rate of variation input deviation.

Integral Action:

action in which contribution to output is proportional to integral of time of input deviation.

Influence of Proportional, Derivative and Integral actions on response of process under control

* An increase in P.B. reduces oscillations but increases deviation.

* A reduction in P.B. reduces the deviation but provokes oscillations of the controlled variable (the system tends to be unstable if P.B. value is too low).

* An increase in Derivative Action corresponds to an increase in Derivative Time, reduces deviation and prevents oscillation up to a critical value of Derivative Time, beyond which deviation increases and prolonged oscillations occur.

* An increase in Integral Action corresponds to a reduction in Integral Time, and tends to eliminate deviation between the controlled variable and the setpoint when the system is running at rated speed.

If the Integral Time value is too long (Weak integral action), deviation between the controlled variable and the setpoint may persist.

Contact GEFRA for more information on control actions.

MULTISET FUNCTION, SET GRADIENT

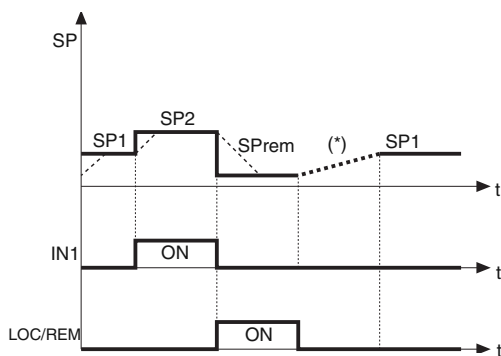

(*) if the set gradient is set

The multiset function is enabled in hd.1.

The gradient function is always enabled.

You can select between setpoint 1 and setpoint 2 with the faceplate key or with digital input.

You can display the setpoint 1-2 selection by means of LED.

SET GRADIENT: if set to $\neq 0$, the setpoint is assumed equal to PV at power-on and auto/man switchover. With gradient set, it reaches the local setpoint or the one selected.

Every variation in setpoint is subject to a gradient.

The set gradient is inhibited at power-on when self-tuning is engaged.

If the set gradient is set to $\neq 0$, it is active even with variations of the local setpoint, settable only on the relative SP menu.

The control setpoint reaches the set value at the speed defined by the gradient.

SOFTWARE ON / OFF SWITCHING FUNCTION

How to switch the unit OFF: hold down the "F" and "Raise" keys simultaneously for 5 seconds to deactivate the unit, which will go to the OFF state while keeping the line supply connected and keeping the process value displayed. The SV display is OFF.

All outputs (alarms and controls) are OFF (logic level 0, relays de-energized) and all unit functions are disabled except the switch-on function and digital communication.

How to switch the unit ON: hold down the "F" key for 5 seconds and the unit will switch OFF to ON. If there is a power failure during the OFF state, the unit will remain in OFF state at the next power-up (ON/OFF state is memorized).

The function is normally enabled, but can be disabled by setting the parameter Prot = Prot +16. This function can be assigned to a digital input (d.i.G) and excludes deactivation from the keyboard.



Your authorised Service Centre is:

Leister Process Technologies
Galileo-Strasse 10
CH-6056 Kaegiswil/Switzerland
Tel. +41-41662 74 74
Fax +41-41662 74 16
www.leister.com
sales@leister.com